

1:1 Ratio Fast-Ball™ Pumps

307906ZAB

EN

For dispensing non-abrasive oils and lubricants only.

Model No. 222051, Series E

Universal Pump

Model No. 222103, Series E

55 Gallon Drum, Bung-Mount Pump

Model No. 222104, Series E

275 Gallon Tank, Bung-Mount Pump

Model No. 685438, Series E

Universal Pump, PTFE Cup

180 psi (1.2MPa, 12.4 bar) Maximum Air and Fluid Working Pressure



Important Safety Instructions

Read all warnings and instructions in this manual. Save these instructions.

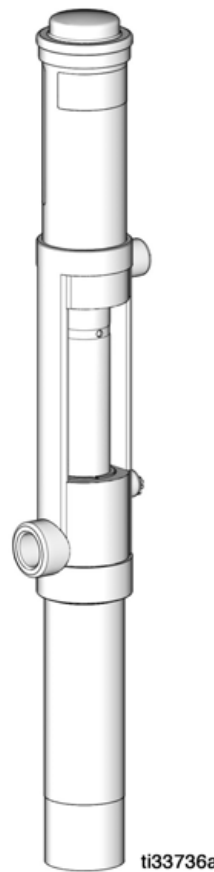

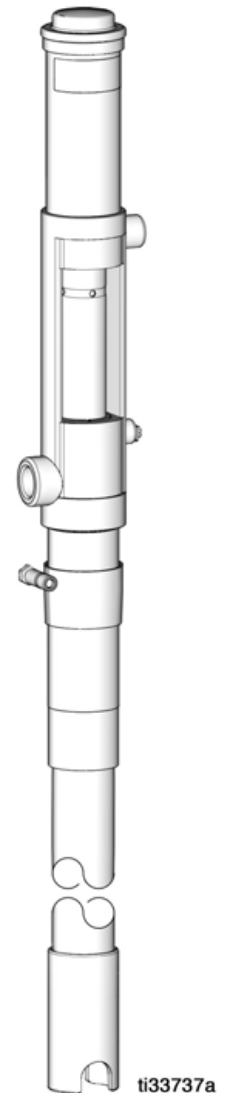

Model 222051









Models 222103 and 222104

Warnings

The following warnings are for the setup, use, grounding, maintenance, and repair of this equipment. The exclamation point symbol alerts you to a general warning and the hazard symbols refer to procedure-specific risks. When these symbols appear in the body of this manual or on warning labels, refer back to these Warnings. Product-specific hazard symbols and warnings not covered in this section may appear throughout the body of this manual where applicable.

 <h2 style="margin: 0;">WARNING</h2>	
	<p>FIRE AND EXPLOSION HAZARD</p> <p>When flammable fluids are present in the work area, such as gasoline and windshield wiper fluid, be aware that flammable fumes can ignite or explode. To help prevent fire and explosion:</p> <ul style="list-style-type: none"> • Use equipment only in well-ventilated area. • Eliminate all ignition sources, such as cigarettes and portable electric lamps. • Ground all equipment in the work area. • Keep work area free of debris, including rags and spilled or open containers of solvent and gasoline. • Do not plug or unplug power cords or turn lights on or off when flammable fumes are present. • Use only grounded hoses. • Stop operation immediately if static sparking occurs or you feel a shock. Do not use equipment until you identify and correct the problem. • Keep a working fire extinguisher in the work area.
	<p>SKIN INJECTION HAZARD</p> <p>High-pressure fluid from dispensing device, hose leaks, or ruptured components will pierce skin. This may look like just a cut, but it is a serious injury that can result in amputation. Get immediate surgical treatment.</p> <ul style="list-style-type: none"> • Do not point dispensing device at anyone or at any part of the body. • Do not put your hand over the fluid outlet. • Do not stop or deflect leaks with your hand, body, glove, or rag. • Follow the Pressure Relief Procedure when you stop dispensing and before cleaning, checking, or servicing equipment. • Tighten all fluid connections before operating the equipment. • Check hoses and couplings daily. Replace worn or damaged parts immediately.

WARNING

 	<p>EQUIPMENT MISUSE HAZARD Misuse can cause death or serious injury.</p> <ul style="list-style-type: none"> • Do not operate the unit when fatigued or under the influence of drugs or alcohol. • Do not exceed the maximum working pressure or temperature rating of the lowest rated system component. See Technical Specifications in all equipment manuals. • Use fluids and solvents that are compatible with equipment wetted parts. See Technical Specifications in all equipment manuals. Read fluid and solvent manufacturer’s warnings. For complete information about your material, request Safety Data Sheets (SDSs) from distributor or retailer. • Turn off all equipment and follow the Pressure Relief Procedure when equipment is not in use. • Check equipment daily. Repair or replace worn or damaged parts immediately with genuine manufacturer’s replacement parts only. • Do not alter or modify equipment. Alterations or modifications may void agency approvals and create safety hazards. • Make sure all equipment is rated and approved for the environment in which you are using it. • Use equipment only for its intended purpose. Call your distributor for information. • Route hoses and cables away from traffic areas, sharp edges, moving parts, and hot surfaces. • Do not kink or over bend hoses or use hoses to pull equipment. • Keep children and animals away from work area. • Comply with all applicable safety regulations.
 	<p>MOVING PARTS HAZARD</p> <p>Moving parts can pinch, cut or amputate fingers and other body parts.</p> <ul style="list-style-type: none"> • Keep clear of moving parts. • Do not operate equipment with protective guards or covers removed. • Pressurized equipment can start without warning. Before checking, moving, or servicing equipment, follow the Pressure Relief Procedure and disconnect all power sources.
	<p>TOXIC FLUID OR FUMES HAZARD</p> <p>Toxic fluids or fumes can cause serious injury or death if splashed in the eyes or on skin, inhaled, or swallowed.</p> <ul style="list-style-type: none"> • Read Safety Data Sheets (SDSs) to know the specific hazards of the fluids you are using. • Route exhaust away from work area. If diaphragm ruptures, fluid may be exhausted into the air. • Store hazardous fluid in approved containers, and dispose of it according to applicable guidelines.
	<p>PERSONAL PROTECTIVE EQUIPMENT</p> <p>Wear appropriate protective equipment when in the work area to help prevent serious injury, including eye injury, hearing loss, inhalation of toxic fumes, and burns. Protective equipment includes but is not limited to:</p> <ul style="list-style-type: none"> • Protective eyewear, and hearing protection. • Respirators, protective clothing, and gloves as recommended by the fluid and solvent manufacturer.

Installation

Typical Installation

Install the accessories in order shown in the typical installation in FIG. 1. The installation shown in FIG. 1 is only a guide for selecting and installing a pump; it is not an actual system design. Contact your Graco distributor for assistance in designing a system to suit your needs.

NOTE: Blow out all lines with compressed air before you connect the pumps.

NOTICE

Always mount the pump firmly to a wall bracket or a bung on a drum. Never operate pump while it is not mounted. Such use could damage the pump and fittings.

NOTICE

Do not hang the air accessories directly on the air inlet (P). The fittings are not strong enough to support the accessories and may break. Provide a bracket on which to mount the accessories.

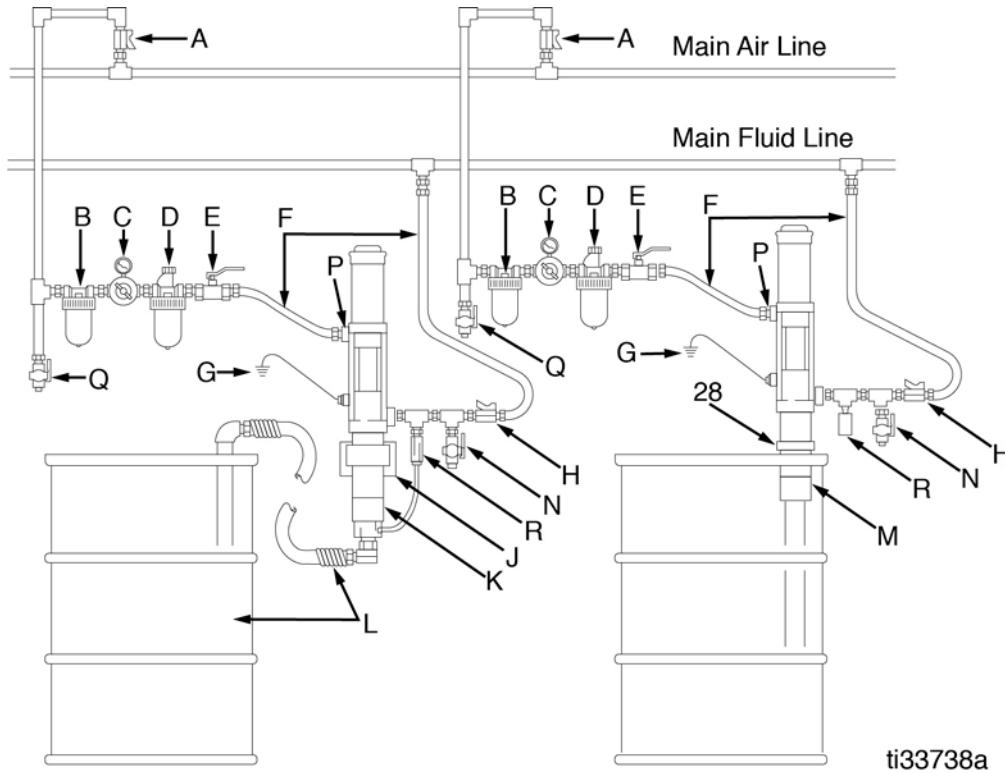





FIG. 1

KEY

- | | |
|---|---|
| <ul style="list-style-type: none"> A Air shutoff valve B Air filter C Air regulator and gauge D Air motor lubricator E Bleed-type master air valve (required, Part No. 110223) F Air and fluid hose kits G Ground wire (required Part No. 222011) H Fluid shutoff valve J Wall bracket | <ul style="list-style-type: none"> K Universal pump (Model 222051) L Suction kit M 55 gallon drum bung-mount pump (Model 222103) N Fluid drain valve (required Part No. 210658) P Air inlet R Thermal relief kit (required for permanent installations, Part No. 237601) 28 Bung adapter |
|---|---|

Grounding

Proper grounding is an essential part of maintaining a safe system.

				
<p>The equipment must be grounded to reduce the risk of static sparking and electric shock. Electric or static sparking can cause fumes to ignite or explode. Improper grounding can cause electric shock. Grounding provides an escape wire for the electric current.</p>				

Pump: use ground wire and clamp (supplied) as shown in FIG. 2.

Air compressor: follow manufacturer's recommendations.

Object being dispensed to: follow local code.

Fluid supply container: follow local code.

To maintain grounding continuity when flushing or relieving pressure: hold metal part of the dispense valve firmly to the side of a grounded metal container, then trigger the valve.

To ground the pump, remove the ground screw (Z) and insert through eye of the ring terminal at the end of the ground wire (Y). Fasten the ground screw back onto the pump and tighten securely. Connect the other end of the wire to a true earth ground. To order a ground wire and clamp, order Part No. 222011.

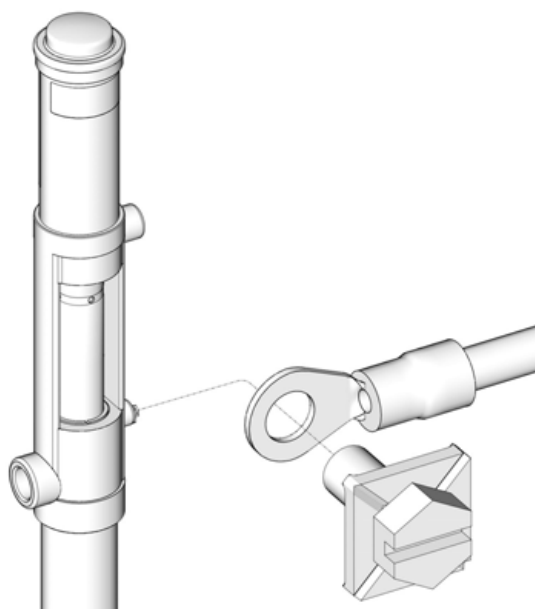





FIG. 2

System Accessories

Refer to FIG. 1, page 4.

Required Accessories

				
<p>Three accessories are required in your system to help reduce the risk of serious bodily injury, including fluid injection, splashing of fluid in eyes or on skin, injury from moving parts when you are adjusting or repairing the pump, and explosion from static sparking.</p>				

- **Bleed-type master air valve (E):** required in your system to relieve air trapped between it and the air motor after the air supply is shut off. Trapped air can cause the air motor to cycle unexpectedly, causing serious injury if you are adjusting or repairing the pump. As an alternative, use a quick-disconnect couple fitting. Install them near the pump air inlet within easy reach from the pump.
- **Fluid drain valve (N):** assists in relieving fluid pressure in the displacement pump, hoses and dispensing valve. Triggering the valve to relieve pressure may not be sufficient.
- **Grounding wire (G):** reduces the risk of static sparking.

Additionally, for permanent installations, a thermal relief kit is required.

- **Thermal Relief Kit (R):** assists in relieving pressure in the pump, hose and dispensing valve due to heat expansion.

Other Accessories

- **Extension Tubes:** Pump models 222103 and 222104 have extension tubes. An extension tube may be added to the Universal pump for use in submerged applications. To install, apply PTFE tape to the female threads at the top of the tube. Thread the tube tightly into the intake housing of the Universal pump. Also install a bung adapter. To order a standard 2-inch bung adapter, order Part No. 222308.

- **Air and Fluid Hose Kits (F):** An 18-inch kit for wall mounted pumps and a 6-foot kit for drum-mounted pumps are available. Use a minimum 1/4-inch ID air supply hose between the pump air inlet and the air accessories. To order a kit with a 1/4-inch air hose, 1/4-inch swivel elbow, 3/4-inch fluid hose, and 3/4-inch swivel elbow, order one of the following kits:
 - 222118 - 18-inch (0.4 m) hose kit for wall mounted pump.
 - 222119 - 6-foot (1.8 m) hose kit for drum mounted pump.
- **Wall Bracket (J):** The wall bracket is used for mounting the Universal pump. The wall bracket is sized to fit any Graco pump designed to use a 2-inch bung adapter. Order Part No. 203987.
- **Runaway Valve:** Install a pump runaway valve to shut off the air to the pump when the pump accelerates beyond the pre-adjusted setting. A pump that is in a runaway condition can be seriously damaged.
- **Air Filter (B):** The air filter removes harmful dirt and moisture from the compressed air supply. A 300 psi (2.1 MPa, 21 bar), 1/4-inch npt(f) air filter (20 micron) is available from Graco. Order Part No. 110146.
- **Air and Fluid Shutoff Valves (A and H):** Install air shutoff valve (A) and fluid shutoff valve (H) as shown in FIG. 1, page 4, to isolate the pump while you are servicing it.
- **Quick-Disconnect Coupler and Nipple:** The quick-disconnect coupler and nipple (not shown) are used to quickly disconnect the air supply. Attach the coupler (Part No. 208536) to the pump air inlet hose, and install the nipple (Part No. 169970) to the pump air inlet (P).
- **Thermal Relief Kit:** Install the thermal relief kit on the dispensing valve side of the pump to assist in relieving pressure in the pump, hose and dispensing valve due to heat expansion. A 600 psi (4.2 MPa, 41 bar) thermal relief kit is available from Graco. Order Part No. 237601.

NOTICE

Never allow the pump to run dry of the fluid being pumped. A dry pump quickly accelerates to a high speed, possibly damaging itself, and it may get very hot.

- **Bleed-Type Master Air Valve (E):** Install a bleed-type master air valve to relieve air trapped between it and the motor when the valve is closed. A 300 psi (2.1 Mpa, 21 bar), 1/4-inch npt(f) bleed type master air valve is available from Graco. Order Part No. 110223.
- **Suction Kit (L):** The suction kit is for use with the wall-mounted Universal pump. It includes a drum tube and hose. Order Part No. 213099.
- **Air Motor Lubricator (D):** The air motor lubricator provides automatic air motor lubrication. A 250 psi (1.7 MPa, 17.4 bar), 1/4-inch npt(f) air motor lubricator is available from Graco. Order Part No. 110148.
- **Air Regulator and Gauge (C):** The air regulator and gauge are used to control air pressure and pump speed. A 0-200 psi (0-1.4 MPa, 0-14 bar) regulated pressure range 300 psi (2.1 MPa, 21 bar) maximum, 1/4-inch npt(f) air regulator and gauge are available from Graco. Order Part No. 110147.

Operation

Pressure Relief Procedure

 Follow the Pressure Relief Procedure whenever you see this symbol.

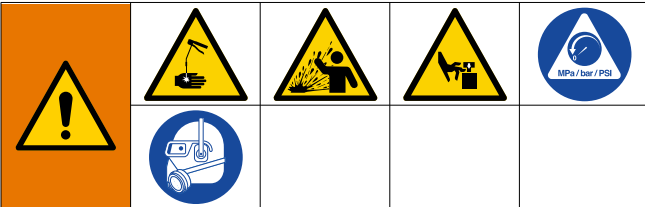

This equipment stays pressurized until pressure is manually relieved. To help prevent serious injury from pressurized fluid, such as skin injection, splashing fluid and moving parts, follow the Pressure Relief Procedure when you stop dispensing and before cleaning, checking, or servicing the equipment.

1. Turn off power supply to the pump.
2. Close the bleed-type master air valve (E) (required in your system).
3. Hold a metal part of the dispensing valve firmly to a grounded metal container and trigger the dispense valve to relieve pressure.

If you suspect that the nozzle or hose is completely clogged, or that pressure has not been fully relieved after you have followed the steps (above), wrap a rag around the hose end coupling and relieve pressure gradually by **very slowly** partially loosening the fitting. Then loosen it completely. Then clear the obstruction.



HAZARDOUS VAPORS
The air motor exhaust coming out of the muffler could contain harmful materials, such as oil, anti-freeze, or some of the material being pumped.

Starting the Pump

1. Turn the air regulator (C) to the minimum setting.
2. Direct the outlet hose into a waste container.
3. Open the bleed-type master air valve (E).
4. Slowly adjust the air regulator (C) until the pump is running smoothly and all air has been pumped out of the pump and hoses. If the pump contains solvent, be sure to pump it all into the waste container.
5. Use the air regulator (C) to control the pump speed and cycle rate. Always use the lowest pressure needed to obtain the desired results. This results in optimum system efficiency and reduces pump wear.

NOTICE
Never allow the pump to run dry of the fluid being pumped. A dry pump quickly accelerates to a high speed, possibly damaging itself, and it may get very hot.

- NOTE:**
- The pump only takes a few strokes to prime. However, in a large system, it may take several minutes to completely prime the fluid lines.
 - To prevent air from being sucked into the pump and fluid lines, if the supply container runs dry, use a low-level cutoff valve at the pump intake. A 1-1/2 inch npt(f) thread connection low level cutoff valve is available from Graco. Order Part No. 203688.

Troubleshooting

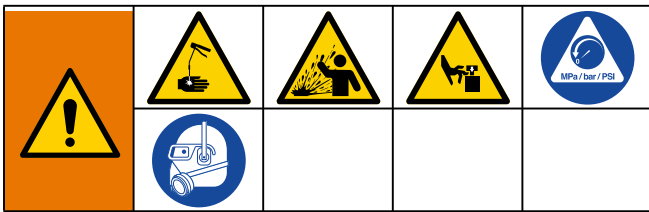

Problem	Cause	Solution
Pump does not run.	There is no fluid demand.	In a closed-end system, the pump runs only when there is demand for fluid.
	Air supply is insufficient.	Check air supply. Increase air pressure or volume.
	Fluid outlet line or intake valve is clogged.	Relieve the pressure , page 7. Check and clear obstacles.
	Air motor parts are worn or damaged.	Check the piston o-rings (15a*, 15b*) and exhaust plate (15c*) for swelling. Replace if necessary. See Service instructions beginning on page 9. Check the piston assembly (15). Be sure its screws are properly torqued (10 to 14 in-lb [1.3 to 1.6 N•m]) and that the assembly is hand-tightened onto the piston rod. Check the springs (8, 17) for wear or damage and replace as needed.
Pump speeds up or runs erratically.	Material viscosity is too high.	Reduce viscosity. Reduce pump speed when running viscous materials.
	Pump throat packings, piston or piston packings, or intake valve is worn.	Relieve the pressure , page 7. Check and repair. See Service instructions beginning on page 9.
Pump slows down or runs erratically.	Air motor is icing.	Shut off pump and allow to warm up. Run pump at a lower air pressure.
Pump runs, but output is low on up or down stroke.	Pump piston and/or intake valve is worn.	Relieve the pressure , page 7. Check and repair. See Service instructions beginning on page 9.
Pump runs, but output is low on both strokes.	Air supply is insufficient.	Check air supply. Increase air pressure or volume.
	Fluid outlet line, intake valve, or dispense valve is clogged.	Relieve the pressure , page 7. Check and repair.

Service

NOTE:

- Clean and inspect all parts for wear or damage when disassembled. Replace parts as needed. Fast-Ball Repair Kit 247431 is available. For best results, use all the parts in the kit.
- In the following instructions, the parts included in the kit are marked with an asterisk in the text, figures, Parts Drawing and Parts List.
- Cup Packing, Part No. 162871 and Packing O-Ring Part No. 154662 are required for servicing pump Model 685438.
- Piston Cup, Part No. 116152 (included in Fast-Ball Repair Kit 247431) can be discarded when servicing pump 685438.

Intake Valve

See the **Parts Drawing**, page 12.



1. **Relieve the pressure**, page 7.
2. Unscrew the valve housing (2). Remove the o-ring (22*), ball (23), and retainer (20).
3. Inspect the parts for wear or damage. If the ball is nicked, replace it. Apply liquid sealant to the male threads and reassemble.

Air Motor

See FIG. 3, page 11.

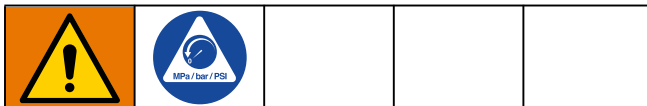

1. **Relieve the pressure**, page 7.
2. Remove the air hose and fluid hoses.
3. Place the air motor base (5) in a vise.



To reduce the risk of injury from trapped air pressure when servicing the air motor, always remove the air cap (2) from the air cylinder (4) before removing the air cylinder from the base (5).

4. Remove the air cap (2). Gently pry the coils of the spring (17) to remove the spring. Check the spring for wear or damage and replace if needed.
5. Use a strap wrench to unscrew the air cylinder (4) from the base (5).
6. Unscrew the air piston assembly (15) from the piston rod (10). Use pliers on the air exhaust plate (15c*) and a wrench on the piston rod. See the **Piston Detail** in FIG. 3, page 11.

NOTE: Old, cured thread sealant on the piston rod threads make it necessary to use tools to remove the air piston assembly from the piston rod. **Do not use these tools when you screw the air piston assembly onto the piston rod.**

7. Disassemble the air piston assembly (15). See the **Piston Detail** in FIG. 3, page 11. Clean all parts and inspect them for wear or damage. If any valve plate spacers are damaged, replace all three in order to maintain the correct clearance between the valve plates and seals.
8. Check the spring (8) for wear or damage and replace as needed.
9. Apply sealant such as Loctite® green to the threads of the screws. Assemble the parts as shown in the **Piston Detail** in FIG. 3, page 11. Torque the screws to 10 to 14 in.-lbs (1.3 to 1.6 N•m).

Pump Lower Repair

See FIG. 3, page 11.

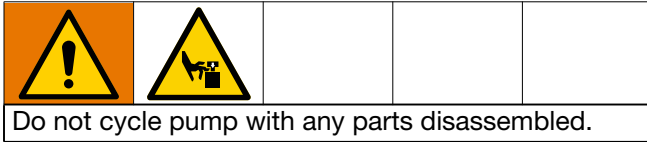

1. Use a strap wrench on the fluid cylinder (24) to unscrew it from the motor base (5). Pull down on the piston rod (10) until you have access to the fluid piston assembly (19).
2. Remove the fluid piston (19) from the piston rod (10) by holding the piston rod stationary while turning the fluid piston out. Be careful to not drop the check ball (18).
3. Use a strap wrench to unscrew the air cylinder (4) from the pump base (5). Carefully lift the air cylinder off the air valve.
4. Carefully remove the piston rod (10) from the pump base (5) by pulling upward on the air valve (15).
5. Remove the shaft seal (16*), wiper ring (11*), and the gasket (9*) from the top of the motor base (5).
6. Reach inside the opening of the air motor base (5) to remove the o-ring (26*). Carefully remove the wiper ring (11*) and the seal (12*) from the motor base.
7. Lubricate and install the new shaft seal (16*), upper wiper ring (11*), gasket (9*), seal (12*), lower wiper ring (11*), and o-ring (26*) into the base (5).
- 8.

For pumps 222051, 222103, or 222104

- a. Remove the washer (19c) and piston seal (19b*) from the fluid piston (19a).
- b. Lubricate the new piston seal (19b*) and install it on the fluid piston (19a).
- c. Install washer (19c) onto fluid piston (19a).

For pump 685438

- a. Remove the washer (19c), piston seal (19b), and piston spacer (19d) from the fluid piston
- b. Remove the spacer o-ring (19e) from inside the piston spacer (19d)
- c. Lubricate and install the new spacer o-ring (19e) inside the piston spacer (19d)
- d. Carefully slide the piston spacer (19d) and o-ring (19e) assembly onto the fluid piston (19a).
- e. Lubricate the new piston seal (19b) and install it on the fluid piston (19a).
- f. Install washer (19c) onto fluid piston (19a).

For all pumps

9. Install the air motor rod assembly by inserting it down through the pump base (5) from the top.
10. Carefully install air cylinder (4) onto the base (5), making sure the gasket (9*) is in place. Screw the cylinder and base together until hand tight.
11. Place the check ball (18) on the fluid piston (19)
12. Apply thread sealant to the threads of the fluid piston (19), screw the fluid piston onto the piston rod (10), and tighten to proper torque. For 222051, 222103, and 222104 the proper torque is 23 ft-lbs (31.2 N-m). For 685438, the proper torque is 50 ft-lbs (68 N-m).
13. Heavily lubricate the top inside diameter of the fluid cylinder (24) and the outside threads. Carefully guide the fluid piston assembly into the fluid cylinder. Push the fluid cylinder up, and screw it into the pump base. Use strap wrench on the knurled part of the intake valve housing (21) to tighten the fluid cylinder and the intake valve to the pump base.

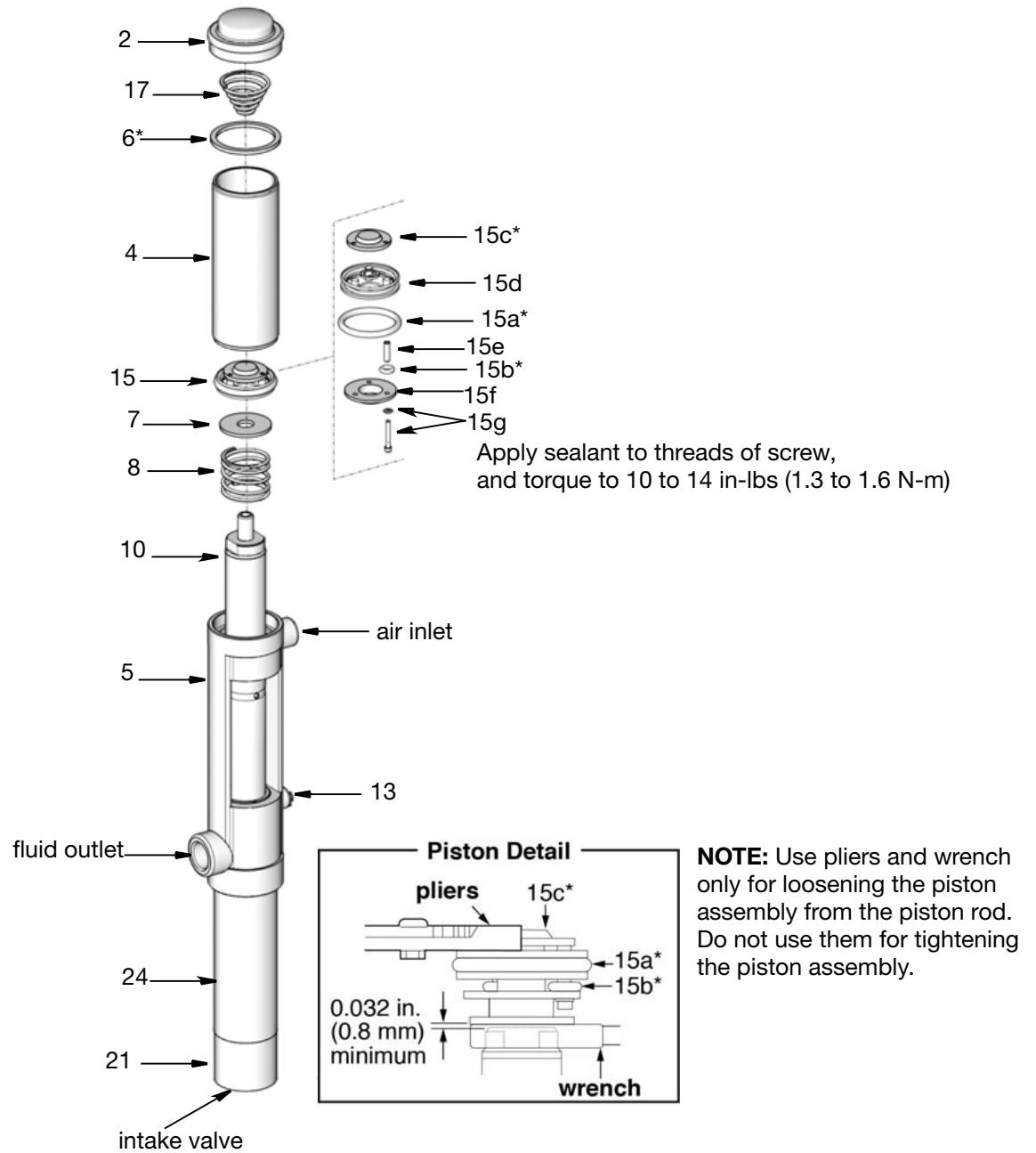
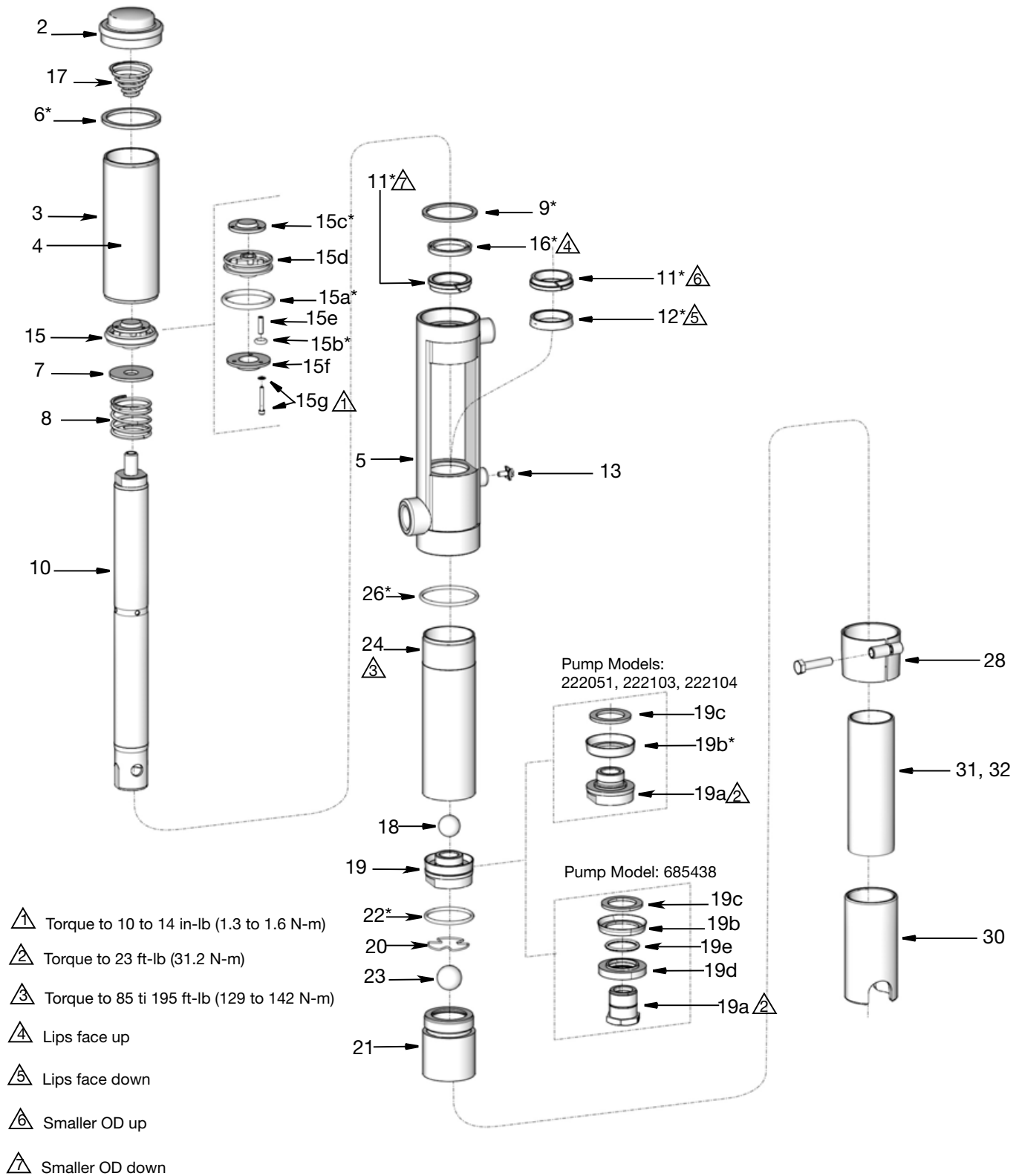

FIG. 3

Parts



Parts

Model 222051, Series E Universal Pump

Includes items 1 through 26

Model 222103, Series E 55 Gallon Drum Bung-Mount Pump

Includes items 1 through 31

Model 222104, Series E 275 Gallon Tank Bung-Mount Pump

Includes items 1 through 30 and 32

Model 685438, Series E Universal Pump, PTFE Cup

Includes items 1 through 21, 23-26

Ref.	Part	Description	Qty.	Ref.	Part	Description	Qty.
1		AIR MOTOR (includes items 2 through 17)	1	19e	154662	O-RING, spacer	1
2	168825	CAP, air motor	1	20	157182	RETAINER, ball	1
3	185218	LABEL, identification	1	21	183009	HOUSING, intake valve	1
4	185528	CYLINDER, air	1	22*	626767	O-RING, nitrile rubber	1
5	183520	BASE, air motor	1	23	101190	BALL, steel; 1 inch (25 mm) dia	1
6*	162989	GASKET	1	24	196803	CYLINDER, fluid (for models 222051, 222103, 222104)	1
7	157872	WASHER, valve	1		191125	CYLINDER, fluid (for model 685438)	1
8	157633	SPRING, compression, piston	1	26*	156641	O-RING, buna-N	1
9*	158109	GASKET	1	28	222308	BUNG ADAPTER	1
10	191389	PISTON ROD	1	30	110127	SPACER, foot	1
11*	185428	WIPER	2	31	191130	TUBE, extension, 55 gallon drum	1
12*	110247	SEAL	1	32	191131	TUBE, extension, 275 gallon tank	1
13	116343	SCREW, ground	1				
15	24J679	KIT, air valve (includes 15a through 15g)	1				
15a*	108357	O-RING	1				
15b*	108358	O-RING	3				
15c*	162729	PLATE, air exhaust valve	1				
15d	189210	PISTON	1				
15e	181485	SPACER, valve plate	1				
15f	181487	PLATE, valve	1				
15g	220884	SCREW/GASKET assembly	1				
16*	121010	SEAL, shaft	1				
17	157630	SPRING, compression	1				
18	100279	BALL, metallic, 0.88 inch (22.2 mm) diameter	1				
19		PISTON, fluid (models 222051, 222103, 222104)	1				
19a	196802	PISTON, fluid	1				
19b*	116152	CUP, piston	1				
19c	116153	WASHER	1				
19		PISTON, fluid (model 685438)	1				
19a	626767	PISTON, fluid	1				
19b	162871	CUP, piston	1				
19c	171594	WASHER	1				
19d	158857	SPACER, piston	1				

▲ Replacement safety labels, tags, and cards are available at no cost.

* Parts included in Kit 247431 (purchase separately).

Technical Specifications

1:1 Ratio Fast-Ball Pump		
	US	Metric
Maximum fluid working pressure	180 psi	1.2 MPa, 12.4 bar
Fluid pressure ratio*	1:1	
Air pressure range	40 to 180 psi	0.28 to 1.2 MPa, 2.8 to 12.4 bar
Air consumption at 1 gpm (3.8 lpm) at 100 psi (0.7 MPa, 7 bar) air pressure	1.5 cfm	0.042 m ³ /minute
Effective piston area	1.48 sq. inches	9.55 sq. cm
Piston rod diameter	1.375 inches	34.9 mm
Stroke length	4 inches	101 mm
Maximum temperature	180°F	82°C
Sound Data (dBa) (measurement taken @ 100 psi (0.7 MPa, 7 bar) air inlet pressure @ 40 cycles per minute per ISO Standard 3744		
Sound pressure level	74.9 dB(A)	
Sound power level	83.5 dB(A)	
Wetted Parts		
Model 222051, 222103, 222104	Carbon steel, Zinc, Aluminum, polyurethane, NBR, UHMWPE	
Model 685438	Carbon steel, Zinc, Aluminum, polyurethane, NBR, PTFE	
Weight		
Model 222051	8 lb.	3.6 kg
Model 222103	13 lb.	5.9 kg
Model 222104	14 lb.	6.4 kg
Model 685438	8 lb.	3.6 kg
Notes		
Loctite® is a registered trademark of the Henkel Corporation.		

Dimension Drawing

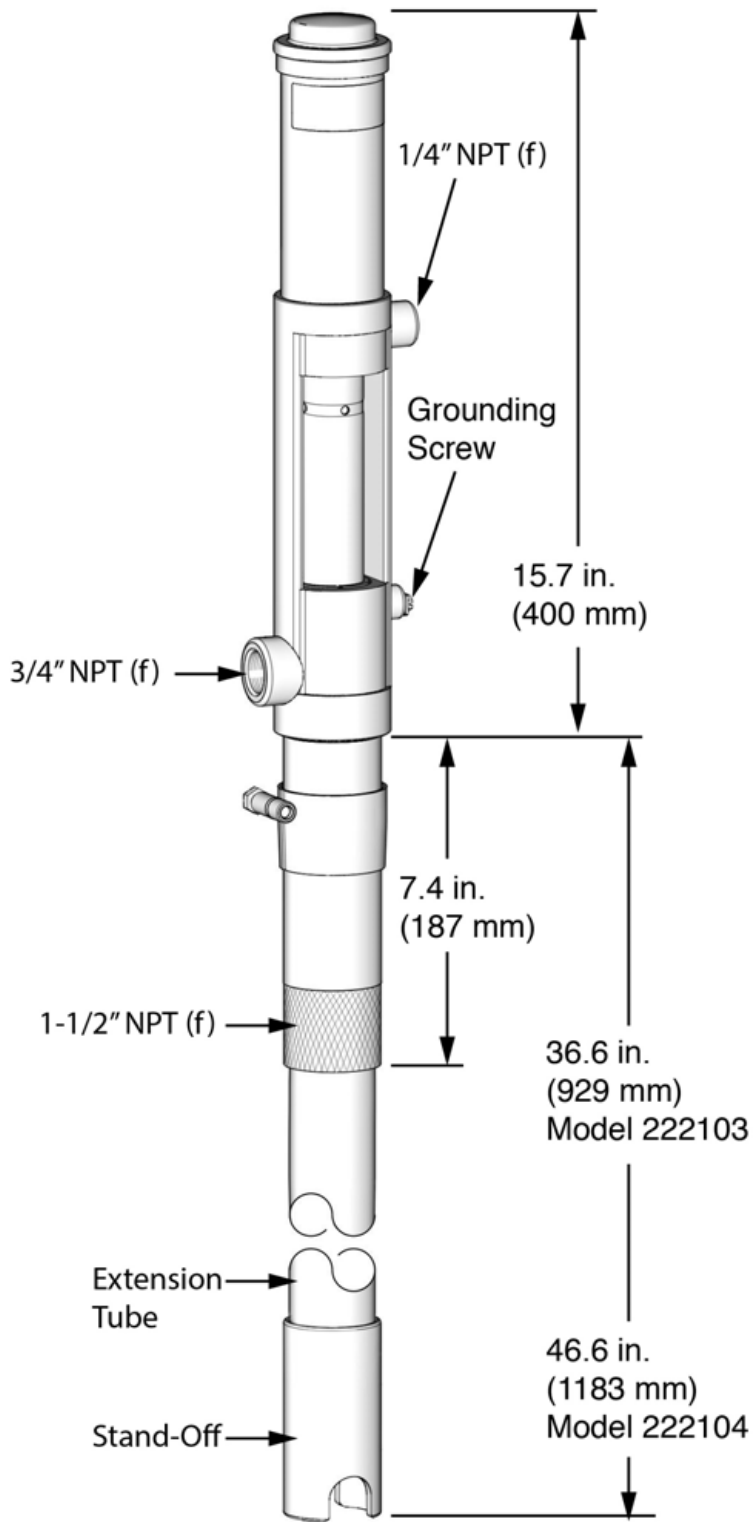

ti33744a

Performance Curve

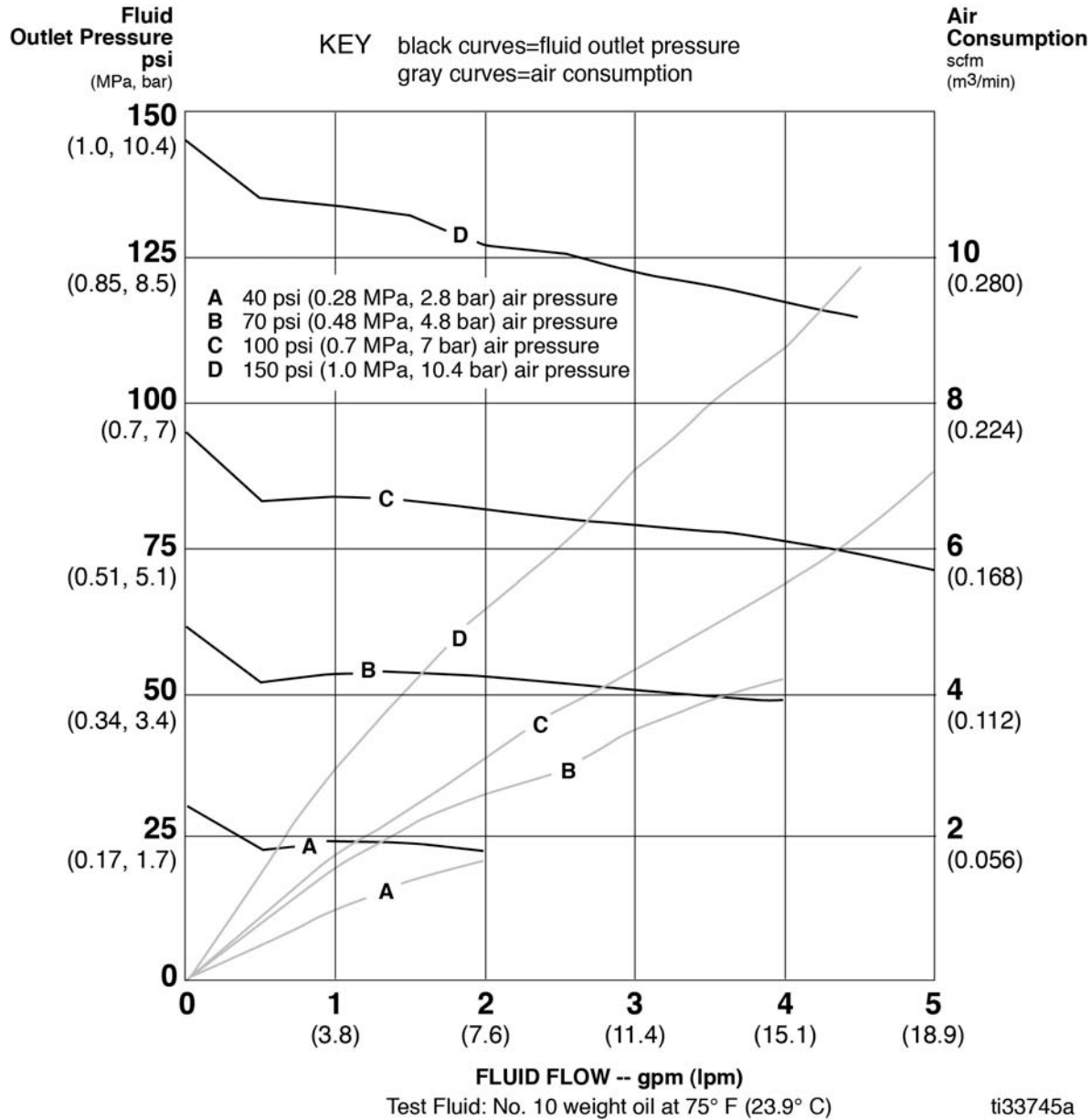

To find fluid outlet pressure at a specific fluid flow and operating air pressure:

1. Locate the desired fluid flow along the bottom of the chart.
2. Follow the vertical line up to the intersection with selected fluid outlet pressure curve (black).
3. Follow left to scale and read fluid outlet pressure.

To find pump air consumption at a specific fluid flow and air pressure:

1. Locate the desired fluid flow along the bottom of the chart.
2. Follow the vertical line up to the intersection with selected air consumption curve (gray).
3. Follow right to scale and read air consumption.

Graco Standard Warranty

Graco warrants all equipment referenced in this document which is manufactured by Graco and bearing its name to be free from defects in material and workmanship on the date of sale to the original purchaser for use. With the exception of any special, extended, or limited warranty published by Graco, Graco will, for a period of twelve months from the date of sale, repair or replace any part of the equipment determined by Graco to be defective. This warranty applies only when the equipment is installed, operated and maintained in accordance with Graco's written recommendations.

This warranty does not cover, and Graco shall not be liable for general wear and tear, or any malfunction, damage or wear caused by faulty installation, misapplication, abrasion, corrosion, inadequate or improper maintenance, negligence, accident, tampering, or substitution of non-Graco component parts. Nor shall Graco be liable for malfunction, damage or wear caused by the incompatibility of Graco equipment with structures, accessories, equipment or materials not supplied by Graco, or the improper design, manufacture, installation, operation or maintenance of structures, accessories, equipment or materials not supplied by Graco.

This warranty is conditioned upon the prepaid return of the equipment claimed to be defective to an authorized Graco distributor for verification of the claimed defect. If the claimed defect is verified, Graco will repair or replace free of charge any defective parts. The equipment will be returned to the original purchaser transportation prepaid. If inspection of the equipment does not disclose any defect in material or workmanship, repairs will be made at a reasonable charge, which charges may include the costs of parts, labor, and transportation.

THIS WARRANTY IS EXCLUSIVE, AND IS IN LIEU OF ANY OTHER WARRANTIES, EXPRESS OR IMPLIED, INCLUDING BUT NOT LIMITED TO WARRANTY OF MERCHANTABILITY OR WARRANTY OF FITNESS FOR A PARTICULAR PURPOSE.

Graco's sole obligation and buyer's sole remedy for any breach of warranty shall be as set forth above. The buyer agrees that no other remedy (including, but not limited to, incidental or consequential damages for lost profits, lost sales, injury to person or property, or any other incidental or consequential loss) shall be available. Any action for breach of warranty must be brought within two (2) years of the date of sale.

GRACO MAKES NO WARRANTY, AND DISCLAIMS ALL IMPLIED WARRANTIES OF MERCHANTABILITY AND FITNESS FOR A PARTICULAR PURPOSE, IN CONNECTION WITH ACCESSORIES, EQUIPMENT, MATERIALS OR COMPONENTS SOLD BUT NOT MANUFACTURED BY GRACO. These items sold, but not manufactured by Graco (such as electric motors, switches, hose, etc.), are subject to the warranty, if any, of their manufacturer. Graco will provide purchaser with reasonable assistance in making any claim for breach of these warranties.

In no event will Graco be liable for indirect, incidental, special or consequential damages resulting from Graco supplying equipment hereunder, or the furnishing, performance, or use of any products or other goods sold hereto, whether due to a breach of contract, breach of warranty, the negligence of Graco, or otherwise.

FOR GRACO CANADA CUSTOMERS

The Parties acknowledge that they have required that the present document, as well as all documents, notices and legal proceedings entered into, given or instituted pursuant hereto or relating directly or indirectly hereto, be drawn up in English. Les parties reconnaissent avoir convenu que la rédaction du présente document sera en Anglais, ainsi que tous documents, avis et procédures judiciaires exécutés, donnés ou intentés, à la suite de ou en rapport, directement ou indirectement, avec les procédures concernées.

Graco Information

For the latest information about Graco products, visit www.graco.com.

For patent information, see www.graco.com/patents.

TO PLACE AN ORDER, contact your Graco distributor or call to identify the nearest distributor.

Phone: 612-623-6928 or Toll Free: 1-800-533-9655, Fax: 612-378-3590

All written and visual data contained in this document reflects the latest product information available at the time of publication. Graco reserves the right to make changes at any time without notice.

Original instructions. This manual contains English. MM307906

Graco Headquarters: Minneapolis

International Offices: Belgium, China, Japan, Korea

GRACO INC. AND SUBSIDIARIES • P.O. BOX 1441 • MINNEAPOLIS MN 55440-1441 • USA
Copyright 1989, Graco Inc. All Graco manufacturing locations are registered to ISO 9001.

www.graco.com
Revised March 2021